

CHITRA  
EUROPEAN FURNITURE



EL ARTE DE SORPRENDER...



B U T A C A S





**CHITRA**  
EUROPEAN FURNITURE

TELA / TISSU  
TECIDO / FABRIC **SKYE**

COLOR: **TELA SKYE BLANCO**



**LUANDA**

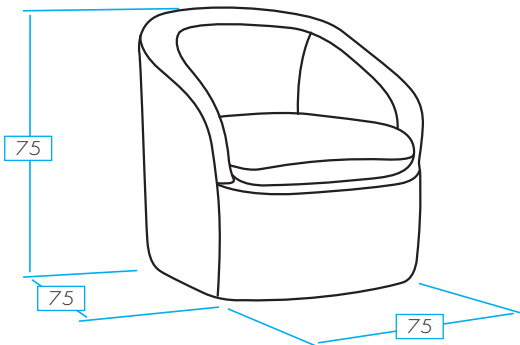

COLOR: **TELA SKYE GRIS OSCURO**

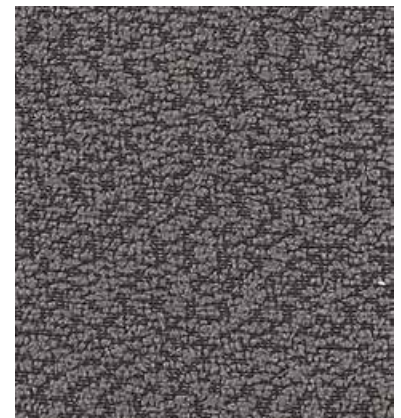

ES

Sillón Fijo giratorio.

EN

Fixed swivel armchair

FR

Fauteuil Fixe pivotant.

PT

Maple fixa giratória.





**CHITRA**  
EUROPEAN FURNITURE

## RIMINI

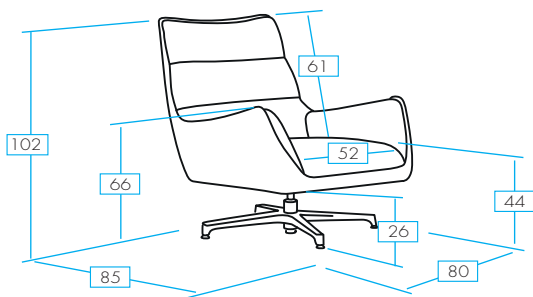

TELA / TISSU  
TECIDO / FABRIC

**TRY**



COLOR: TELA TRY GRIS



COLOR: TELA TRY AMARILLO

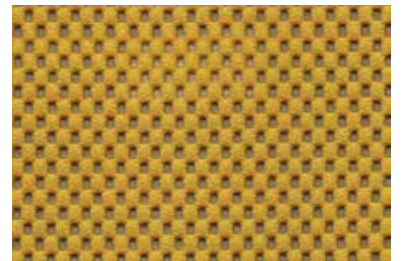

COLOR: TELA TRY AZUL



ES

Sillón Fijo giratorio.

PT

Maple fixa giratória.

FR

Fauteuil Fixe pivotant.

EN

Gyratory fixed armchair





**CHITRA**  
EUROPEAN FURNITURE

## C A M B O Y A

COLOR: **MICROFIBRA CHOCOLATE**



COLOR: **MICROFIBRA AZUL**

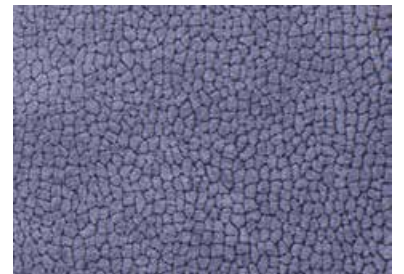

COLOR: **MICROFIBRA ARENA**

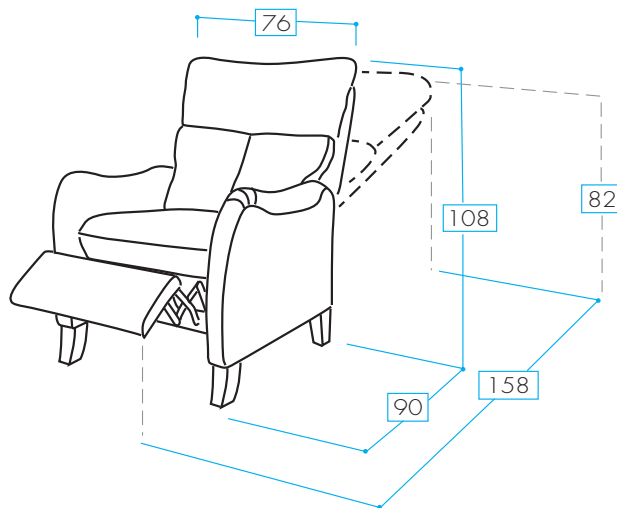

MAX.

**120**  
Kg

ES

Sillón: 1 mecanismo PUSH BACK.

EN

Armchair: 1 PUSH BACK mechanism.

FR

Fauteuil: 1 mécanisme PUSH BACK.

PT

Maple: 1 mecanismo PUSH BACK.



**CHITRA**  
EUROPEAN FURNITURE

## ALMERIA

TELA / TISSU  
TECIDO / FABRIC

**TUI**



COLOR: TELA **TUI MARFIL**

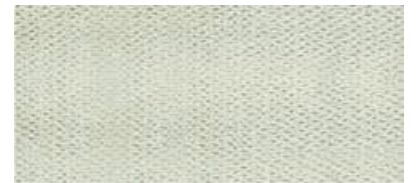

MAX.  
120  
Kg



COLOR: TELA **TUI GRIS OSCURO**

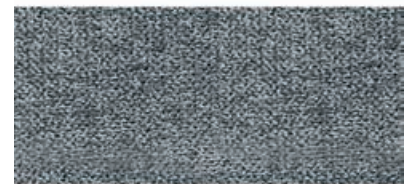

COLOR: TELA **TUI CREMA**



COLOR: TELA **TUI GRIS PERLA**

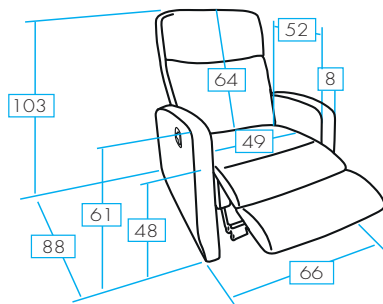

ES

Sillón: 1 mecanismo relax eléctrico.  
Sillón: 1 mecanismo relax manual.

PT

Maple: 1 mecanismo relax eléctrico.  
Maple: 1 mecanismo relax manual.

FR

Fauteuil: 1 mécanisme relax électrique.  
Fauteuil: 1 mécanisme relax manuel.

EN

Maple: 1 electric relax mechanism.  
Maple: 1 manual relax mechanism.



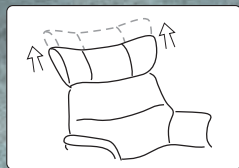

CABEZAL REGULABLE EN ALTURA

**CHITRA**  
EUROPEAN FURNITURE



COLOR: **MICROFIBRA GRIS**



## OSAKA

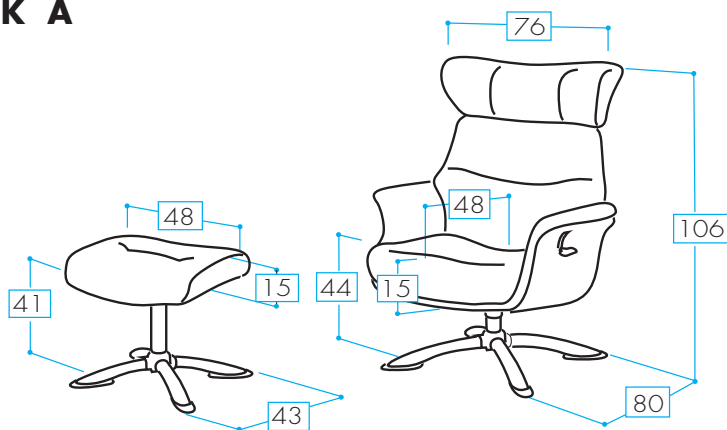

COLOR: **MICROFIBRA AZUL OSCURO**



ES

Sillón: Mecanismo reclinable + pouff.

EN

Reclining mechanism + pouff.

FR

Fauteuil: Mécanisme inclinable + pouff.

PT

Maple: Mecanismo reclinável + pouff.



**CHITRA**  
EUROPEAN FURNITURE

## ATLANTA

TELA / TISSU  
TECIDO / FABRIC

**VIC**

COLOR: TELA **VIC BEIGE**



COLOR: TELA **VIC GRIS OSCURO**

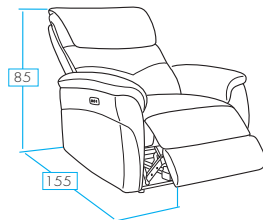
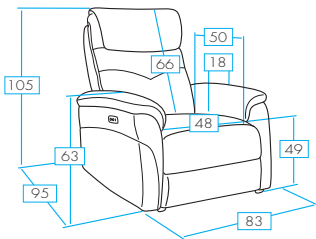
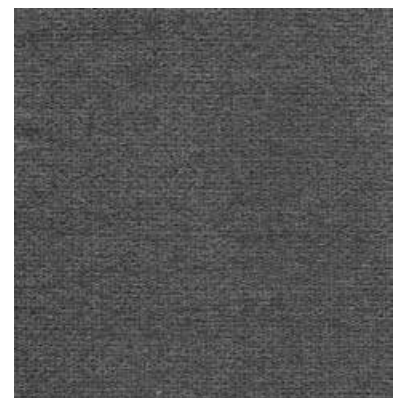

MAX.  
120  
Kg

BATERÍA  
OPCIONAL

CONEXIÓN  
USB

ES

Sillón: 1 mecanismo relax eléctrico 1 motor  
+ Entrada USB.

PT

Maple: 1 mecanismo de relaxamento eléctrico  
1 motor + entrada USB.

FR

Fauteuil: 1 mécanisme relax électrique avec  
1 moteur + USB connexion.

EN

Armchair: 1 electric relaxation mechanism  
1 motor + USB input





**CHITRA**  
EUROPEAN FURNITURE



COLOR: **MICROFIBRA GRIS CLARO**



## L I M A

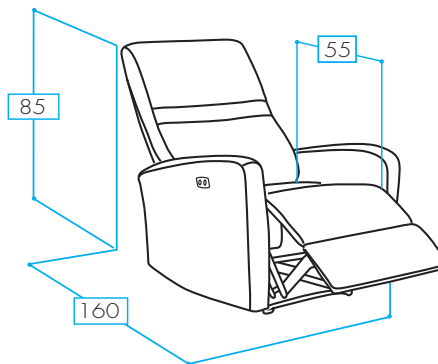
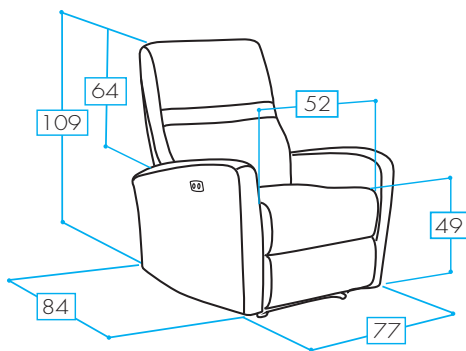

COLOR: **MICROFIBRA GRIS OSCURO**



ES

Sillón: 1 mecanismo relax eléctrico

EN

Armchair: 1 electric relax mechanism.

FR

Fauteuil: 1 mécanisme relax électrique.

PT

Maple: 1 mecanismo relax eléctrico.





USB + USB-C



**CHITRA**  
EUROPEAN FURNITURE

## CASTELLON

TELA / TISSU  
TECIDO / FABRIC

**SIDI**

COLOR: TELA **SIDI GRIS OSCURO**

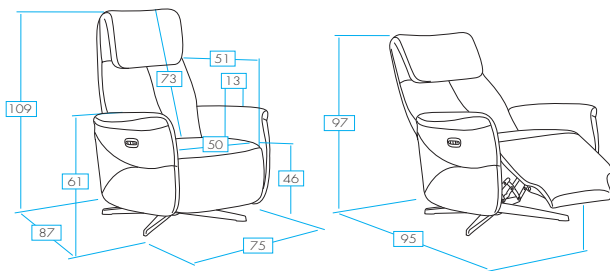

COLOR: TELA **SIDI GRIS CLARO**



ES

Sillón: 1 mecanismo relax eléctrico 2 motores  
+ Entrada USB + USB-C en la botonera.

PT

Maple: 1 relax eléctrico 2 motores + entrada USB  
+ USB-C no painel de botões.

FR

Fauteuil: 1 mécanisme relax électrique 2 moteurs  
+ USB connexion + USB-C sur les boutons.

EN

Armchair: 2 electric relaxation mechanisms  
2 motors + USB-C input



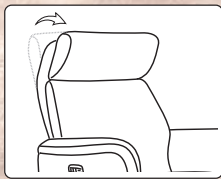

CABEZAL MANUAL

**CHITRA**  
EUROPEAN FURNITURE



## ELCHE

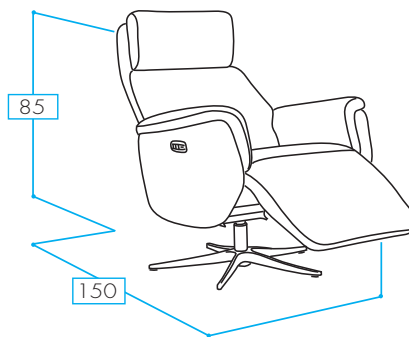
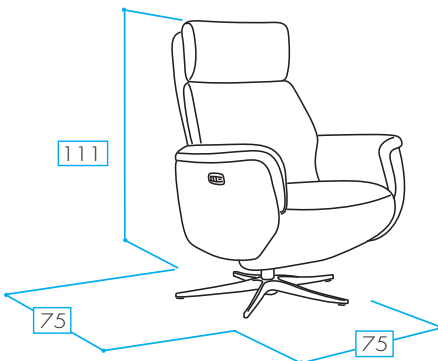

COLOR: **TELA GRIS OSCURO**



COLOR: **TELA GRIS CLARO**



ES

Sillón: 1 mecanismo relax eléctrico 2 motores, cabezal regulable manualmente + Entrada USB.

FR

Fauteuil: 1 mécanisme relax électrique 2 moteurs, tête réglable manuellement + USB connexion

EN

Armchair: 1 electric relax mechanism with 2 engines, headrest manually adjustable + USB connection

PT

Maple: 1 mecanismo relax eléctrico 2 motores, cabeça ajustável manualmente + entrada USB.





NEW NOBUCK GRIS OSCURO

PIEL GRIS CLARO

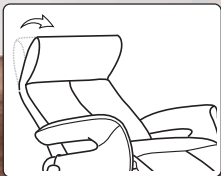

CABEZAL MANUAL

**CHITRA**  
EUROPEAN FURNITURE



COLOR: PIEL ESPESORADA GRIS OSCURO



COLOR: PIEL ESPESORADA GRIS CLARO



COLOR: NEW NOBUCK GRIS OSCURO



COLOR: NEW NOBUCK BEIGE



## GRECIA

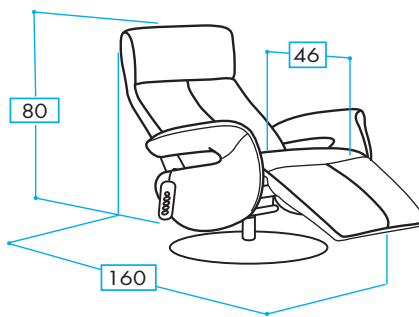
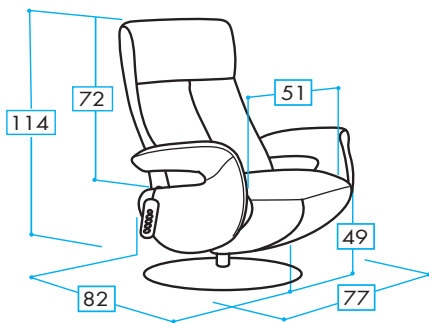

ES

Sillón: 1 mecanismo relax eléctrico 2 motores.  
Cabezal regulable manualmente.

FR

Fauteuil: 1 mécanisme relax électrique 2 moteurs.  
Tête réglable manuellement.

EN

Armchair: 1 electric relax mechanism with 2 engines.  
Headrest manually adjustable.

PT

Maple: 1 mecanismo relax eléctrico 2 motores.  
Cabeça ajustável manualmente.



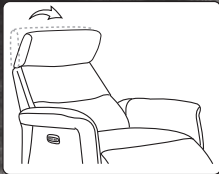

RELAX ELÉCTRICO 2 MOTORES  
+ CABEZAL MANUAL REGULABLE

**CHITRA**  
EUROPEAN FURNITURE



COLOR: **MICROFIBRA AZUL**



## INDIANA MICROFIBRA

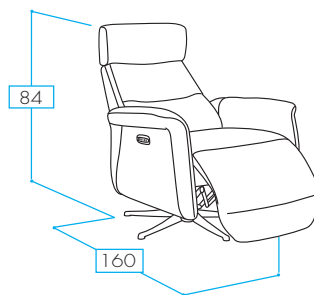
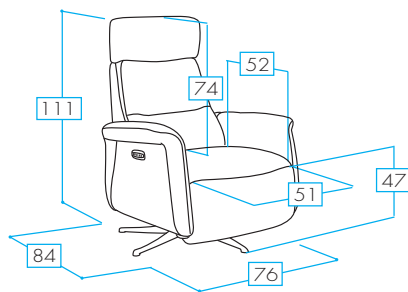

COLOR: **MICROFIBRA AMARILLO**



ES

Sillón: 1 mecanismo relax eléctrico 2 motores  
+ Cabezal manual regulable + Entrada USB.

EN

Armchair: 1 electric relax mechanism with 2 engines  
+ Manually adjustable headrest + USB connection.

FR

Fauteuil: 1 mécanisme relax électrique avec 2 moteurs  
+ Tête réglable manuellement + USB connexion

PT

Maple: 1 mecanismo de relaxamento elétrico, 2 motores  
+ Cabeça ajustável manualmente + entrada USB.

COLOR: **MICROFIBRA GRIS**





**CHITRA**  
EUROPEAN FURNITURE

## A L I C A N T E

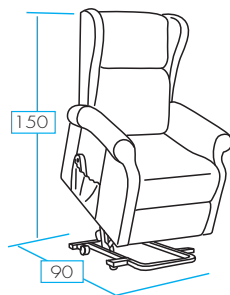
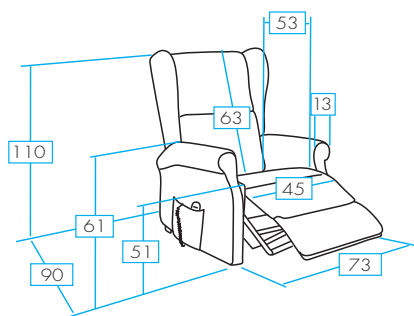

TELA / TISSU  
TECIDO / FABRIC

**TUI**



COLOR: TELA **TUI MARFIL**

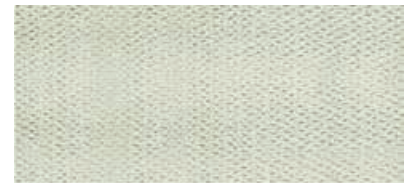

MAX.  
**120  
Kg**



COLOR: TELA **TUI GRIS OSCURO**

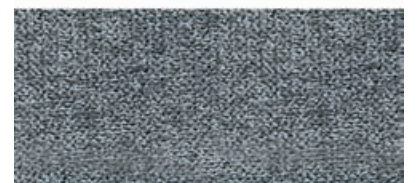

COLOR: TELA **TUI CREMA**



COLOR: TELA **TUI GRIS PERLA**



ES

Sillón: 1 mecanismo relax eléctrico  
+ Función POWERLIFT.

PT

Maple: 1 mecanismo relax eléctrico  
+ Função POWERLIFT

FR

Fauteuil: 1 mécanisme relax électrique  
+ Fonction POWERLIFT.

EN

Armchair: 1 electric relax mechanism  
+ POWERLIFT function.





**CHITRA**  
EUROPEAN FURNITURE

## J A É N

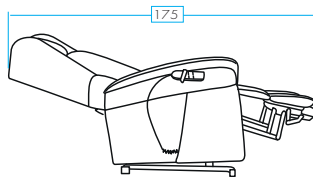
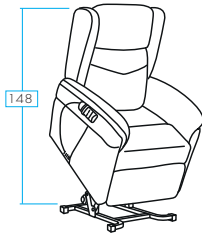
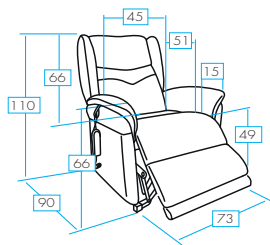

TELA / TISSU  
TECIDO / FABRIC

**ZAR**



MAX.  
120  
Kg



COLOR: TELA ZAR BEIGE



COLOR: TELA ZAR GRIS OSCURO



ES

Sillón: 1 mecanismo relax eléctrico 2 motores + Función POWERLIFT + Inclinación horizontal 180° - Función CAMA

PT

Maple: 1 mecanismo relax eléctrico 2 motores + Função POWERLIFT + função de inclinação horizontal 180° - Função de cama

FR

Fauteuil: 1 mécanisme relax électrique 2 moteurs + Fonction POWERLIFT + Inclinaison horizontale 180° - Fonction LIT.

EN

Armchair: 1 electric relaxation mechanism 2 motors + POWERLIFT function + 180° horizontal inclination function - Bed function





**CHITRA**  
EUROPEAN FURNITURE

## L O N D O N

TELA / TISSU  
TECIDO / FABRIC

# MILO

COLOR: TELA **MILO GRIS PERLA**

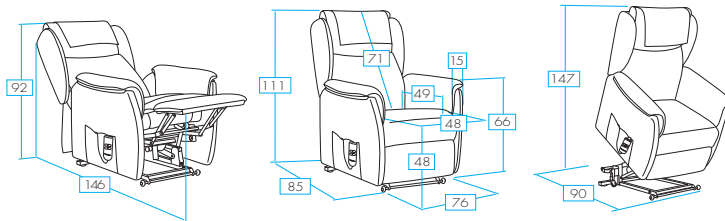

COLOR: TELA **MILO MARRÓN**

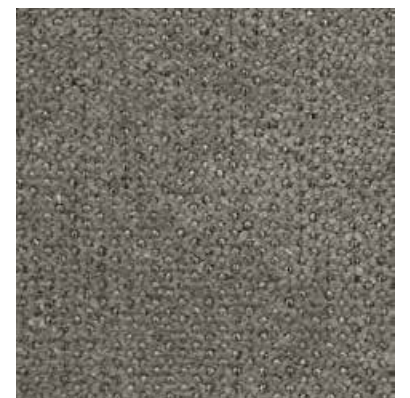

ES

Sillón: 1 mecanismo relax eléctrico 2 motores + Función POWERLIFT.

PT

Maple: 1 mecanismo relax eléctrico 2 motores + Função POWERLIFT.

FR

Fauteuil: 1 mécanisme relax électrique avec 2 moteurs + Fonction Releveur.

EN

Armchair: 1 electric relaxation mechanism 2 motors + POWERLIFT function





**CHITRA**  
EUROPEAN FURNITURE

## R O N D A

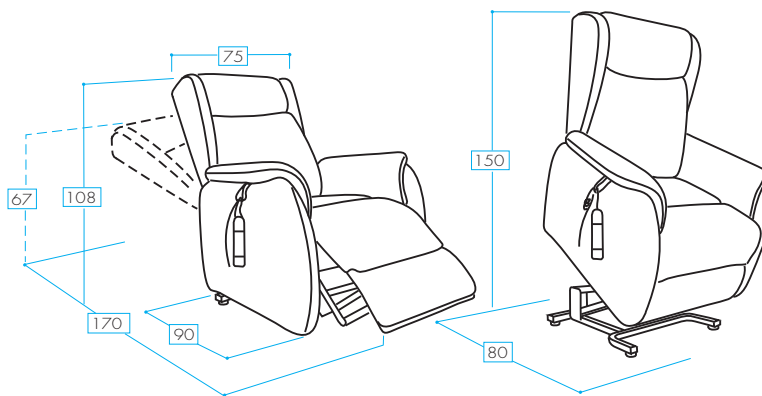

COLOR: **NEW NOBUCK GRIS OSCURO**



COLOR: **NEW NOBUCK BEIGE**



COLOR: **NEW NOBUCK MARRÓN**



ES

Sillón: 1 mecanismo relax eléctrico 2 motores + Función POWERLIFT + Inclinación horizontal 180° - Función CAMA.

EN

Armchair: 1 electric relax mechanism with 2 engines + POWERLIFT function + Horizontal inclination 180° - Bed function.

FR

Fauteuil: 1 mécanisme relax électrique avec 2 moteurs + Fonction POWERLIFT + Inclinaison horizontale 180° - Fonction LIT.

PT

Maple: 1 mecanismo relax eléctrico 2 motores + Função POWERLIFT + função de inclinação horizontal 180° - Função CAMA



**CHITRA**  
EUROPEAN FURNITURE

## TREVISO

TELA / TISSU  
TECIDO / FABRIC

**DYC**

COLOR: TELA **DYC CREMA**

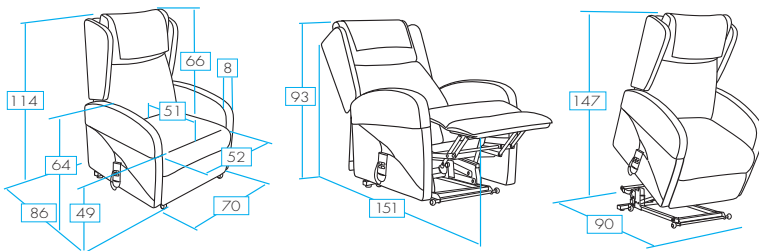

COLOR: TELA **DYC GRIS**

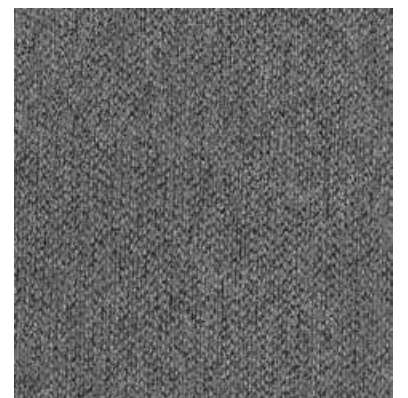

ES

Sillón: 1 mecanismo relax eléctrico 2 motores  
+ Función POWERLIFT.

PT

Maple: 1 mecanismo relax eléctrico 2 motores  
+ Função POWERLIFT.

FR

Fauteuil: 1 mécanisme relax électrique avec 2  
moteurs + Fonction Releveur.

EN

Armchair: 1 electric relaxation mechanism 2  
motors + POWERLIFT function



TODO PIEL  
ALL LEATHER  
TOUT CUIR  
TODO PELLE



RELAX ELÉCTRICO 2 MOTORES  
+ CABEZAL MANUAL REGULABLE

**CHITRA**  
EUROPEAN FURNITURE



COLOR: **PIEL TOFFEE**



## INDIANA PIEL

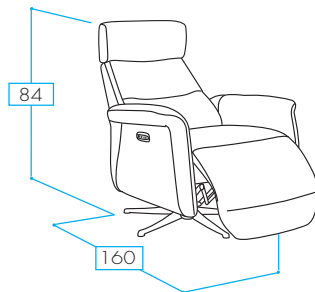
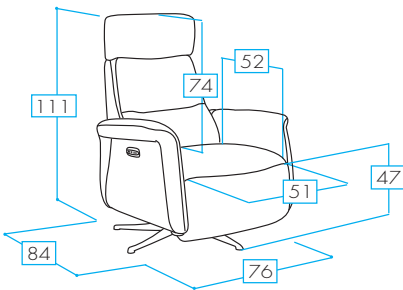

COLOR: **PIEL MARRÓN**

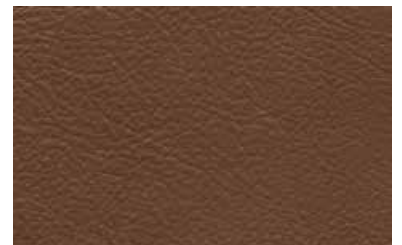

ES

Sillón: 1 mecanismo relax eléctrico 2 motores  
+ Cabezal manual regulable + Entrada USB.

EN

Armchair: 1 electric relax mechanism with 2 engines  
+ Manually adjustable headrest + USB connection.

FR

Fauteuil: 1 mécanisme relax électrique avec 2 moteurs  
+ Tête réglable manuellement + USB connexion

PT

Maple: 1 mecanismo de relaxamento elétrico, 2 motores  
+ Cabeça ajustável manualmente + entrada USB.

COLOR: **PIEL BLANCO**

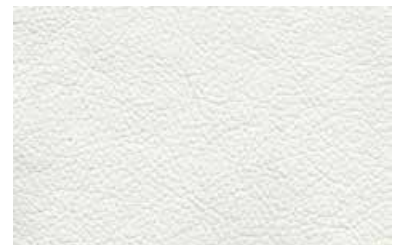





---

S O F Á S



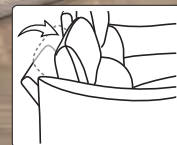

CABEZAL MANUAL

**CHITRA**  
EUROPEAN FURNITURE

## BERGAMO

TELA / TISSU  
TECIDO / FABRIC

VIP



COLOR: TELA VIP AZUL

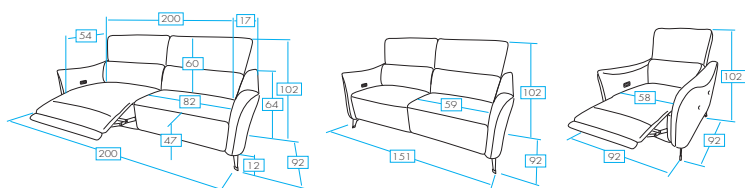

COLOR: TELA VIP GRIS



COLOR: TELA VIP BEIGE



ES

- 3 plazas: 2 relax eléctricos
- + 2 cabezales manuales.
- 2 plazas: fijo.
- Sillón: 1 relax eléctrico + cabezal manual.

PT

- 3 Lugares: 2 relax elétricos
- + 2 cabeçais manuais.
- 2 Lugares: fixo.
- Maple: 1 relax eléctrico + cabeçal manual.

FR

- 3 places: 2 relax électriques
- + 2 têtes manuelles.
- 2 places: Fixe.
- Fauteuil: 1 relax électrique + tête manuelle.

EN

- 3 seats: 2 electric relax mechanisms.
- + 2 manual headrests.
- 2 places: fixed.
- Armchair: 1 electric relax + manual headrest





MECANISMO PARED "0"

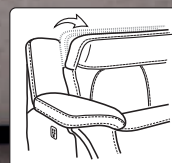

CABEZAL ELÉCTRICO

**CHITRA**  
EUROPEAN FURNITURE

## BILBAO MICROFIBRA

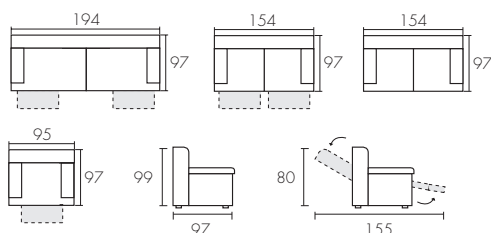

COLOR: **MICROFIBRA GRIS** (Hilo color naranja)



ES

- 3 plazas: 2 relax eléctricos y 2 cabezales eléctricos
- 2 plazas: 2 relax eléctricos y 2 cabezales eléctricos
- 2 plazas: fijo.
- Sillón: 1 relax eléctrico y 1 cabezal eléctrico.

EN

- 3 seats: 2 electric relaxing plus electric headrest.
- 2 seats: 2 electric relaxing plus electric headrest.
- 2 seats: Fixed.
- Armchair: 1 electric relaxing plus electric headrest.

FR

- 3 pl: 2 relax électriques et têtes électriques.
- 2 pl: 2 relax électriques avec têtes électriques.
- 2 pl: Fixe.
- Fauteuil: 1 relax électrique avec têtes électriques

PT

- 3 Lugares: 2 Relax elétricos y cabeçais
- 2 Lugares: 2 Relax elétricos y cabeçais
- 2 Lugares: fixo
- Maple: 1 mecanismo Relax elétrico e cabeçal

COLOR: **MICROFIBRA MARRÓN** (Hilo color naranja)







CABEZAL ELÉCTRICO

**CHITRA**  
EUROPEAN FURNITURE

## BOMBAY

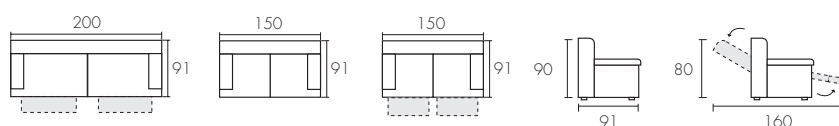

COLOR: **TEJIDO GRIS OSCURO**



COLOR: **TEJIDO GRIS CLARO**



**ES**

- 3 plazas: 2 relax eléctricos y 2 cabezales eléctricos
- 2 plazas: 2 relax eléctricos y 2 cabezales eléctricos
- 2 plazas: 2 fijo y 2 cabezales elevables manuales
- Sillón: 1 relax eléctrico y 1 cabezal eléctrico.

**EN**

- 3 seats: 2 electric relaxing plus 2 electric headrest.
- 2 seats: 2 electric relaxing plus 2 electric headrest.
- 2 seats: Fixed plus 2 manual lift headrests
- Armchair: 1 electric relaxing plus 1 electric headrest.

**FR**

- 3 pl: 2 relax électriques et 2 têtes électriques.
- 2 pl: 2 relax électriques et 2 têtes électriques.
- 2 pl: Fixe et 2 têtes élevables manuelles
- Fauteuil: 1 relax électrique et 1 tête électrique.

**PT**

- 3 Lugares: 2 relax elétricos e 2 cabeçais elétricos.
- 2 Lugares: 2 relax elétricos e 2 cabeçais elétricos.
- 2 Lugares: Fixo e 2 cabeçais de elevação manuais
- Maple: 1 relax elétrico e 1 cabeçal elétrico.





**CHITRA**  
EUROPEAN FURNITURE

## CANTABRIA

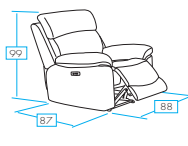
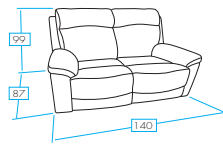
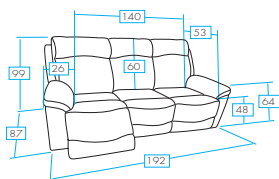

TELA / TISSU  
TECIDO / FABRIC

**TUI**



COLOR: TELA TUI GRIS OSCURO



COLOR: TELA TUI MARFIL



ES

- 3 plazas: 2 mecanismos relax eléctricos.
- 3 plazas: 2 mecanismos relax manuales.
- 2 plazas: fijo.
- Sillón: 1 mecanismo relax eléctrico.
- Sillón: 1 mecanismo relax manual.

PT

- 3 Lugares: 2 mecanismos relax elétricos.
- 3 Lugares: 2 mecanismos relax manuales.
- 2 Lugares: fixo.
- Maple: 1 mecanismo relax eléctrico.
- Maple: 1 mecanismo relax manual.

FR

- 3 places: 2 relax électriques.
- 3 places: 2 relax manuels.
- 2 places: Fixe.
- Fauteuil: 1 mécanisme relax électrique.
- Fauteuil: 1 mécanisme relax manuel.

EN

- 3 seats: 2 electric relax mechanisms.
- 3 seats: 2 manual relax mechanisms.
- 2 places: fixed.
- Armchair: 1 electric relax mechanism.
- Armchair: 1 manual relax mechanism.





RELAX Y CABEZALES  
ELÉCTRICOS

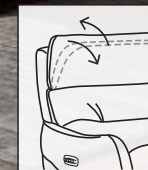

CABEZAL ELÉCTRICO

**CHITRA**  
EUROPEAN FURNITURE

## COLONIA MICROFIBRA

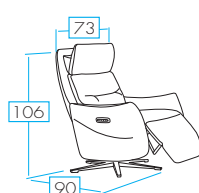
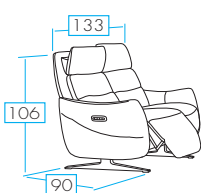
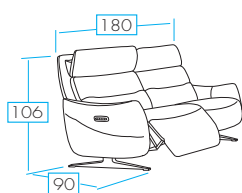

COLOR: **MICROFIBRA AZUL**



COLOR: **MICROFIBRA AMARILLO**

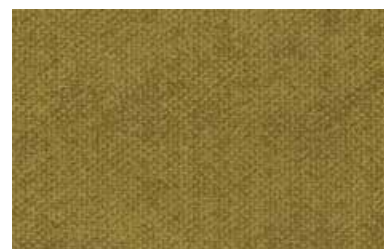

COLOR: **MICROFIBRA GRIS**



ES

- 3 plazas: 4 mecanismos relax eléctricos + 2 cabezales eléctricos + entrada USB.
- 2 plazas: 4 mecanismos relax eléctricos + 2 cabezales eléctricos + entrada USB.
- 2 plazas: fijo.
- Sillón: 2 mecanismos relax eléctrico + Cabezal eléctrico + entrada USB.

EN

- 3 seats: 4 electric relaxing mechanisms + 2 electric headrests + USB connection.
- 2 seats: 4 electric relaxing mechanisms + 2 electric headrests + USB connection.
- 2 seats: Fixed.
- Armchair: 2 electric relaxing mechanisms + electric headrest + USB connection.

FR

- 3 places: 4 mécanismes relax électriques + 2 têtes électriques + USB connexion.
- 2 places: 4 mécanismes relax électriques + 2 têtes électriques + USB connexion.
- 2 places: Fixe.
- Fauteuil: 2 mécanismes relax électriques + tête électrique + USB connexion.

PT

- 3 Lugares: 4 mecanismos relax eléctricos + 2 cabeçal eléctricos + entrada USB.
- 2 Lugares: 4 mecanismos relax eléctricos + 2 cabeçal eléctricos + entrada USB.
- 2 Lugares: fixo.
- Maple: 2 mecanismos relax eléctricos + cabeçal eléctrico + entrada USB.



**CHITRA**  
EUROPEAN FURNITURE

## COLUMBIA

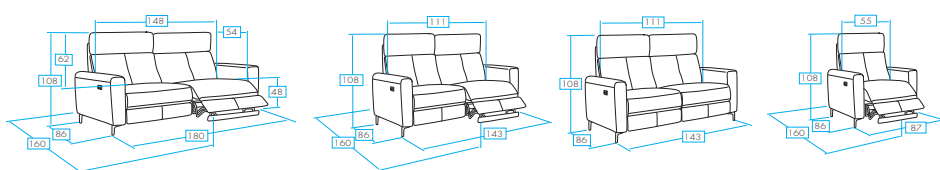

COLOR: **NEW NOBUCK BEIGE**



COLOR: **NEW NOBUCK GRIS OSCURO**



ES

- 3 plazas: 2 mecanismos relax eléctricos.
- 2 plazas: 2 mecanismos relax eléctricos.
- 2 plazas: fijo.
- Sillón: 1 mecanismo relax eléctrico.

EN

- 3 seats: 2 electric relaxing mechanisms.
- 2 seats: 2 electric relaxing mechanisms.
- 2 seats: Fixed.
- Armchair: 1 electric relaxing mechanism.

FR

- 3 places: 2 relax électriques.
- 2 places: 2 relax électriques.
- 2 places: Fixe.
- Fauteuil: 1 mécanisme relax électrique.

PT

- 3 Lugares: 2 mecanismos relax elétricos.
- 2 Lugares: 2 mecanismos relax elétricos.
- 2 Lugares: fixo.
- Maple: 1 mecanismo relax eléctrico.





MECANISMO PARED "0"

**CHITRA**  
EUROPEAN FURNITURE

## F A R O

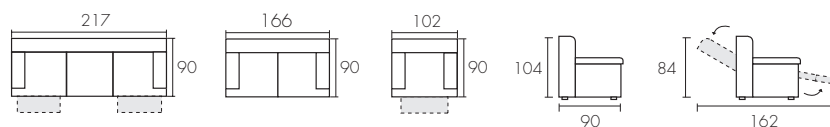

COLOR: **NEW NOBUCK CHOCOLATE** (Hilo color dorado)



COLOR: **NEW NOBUCK GRIS OSCURO** (Hilo color blanco)



COLOR: **NEW NOBUCK BEIGE** (Hilo color beige)



### ES

- 3 plazas: 2 mecanismos relax eléctricos.
- 3 plazas: 2 mecanismos relax manuales.
- 2 plazas: fijo.
- Sillón: 1 mecanismo relax eléctrico.
- Sillón: 1 mecanismo relax manual.

### EN

- 3 seats: 2 electric relaxing mechanisms.
- 3 seats: 2 manual relaxing mechanisms.
- 2 seats: Fixed.
- Armchair: 1 electric relaxing mechanism.
- Armchair: 1 manual relaxing mechanism.

### FR

- 3 places: 2 mécanismes relax électriques.
- 3 places: 2 mécanismes relax manuels.
- 2 places: Fixe.
- Fauteuil: 1 mécanisme relax électrique.
- Fauteuil: 1 mécanisme manual électrique.

### PT

- 3 Lugares: 2 mecanismos relax eléctricos.
- 3 Lugares: 2 mecanismos relax manuais.
- 2 Lugares: fixo.
- Maple: 1 mecanismo relax eléctrico.
- Maple: 1 mecanismo relax manual.





CABEZAL ABATIBLE



**CHITRA**  
EUROPEAN FURNITURE

## FIORELLA

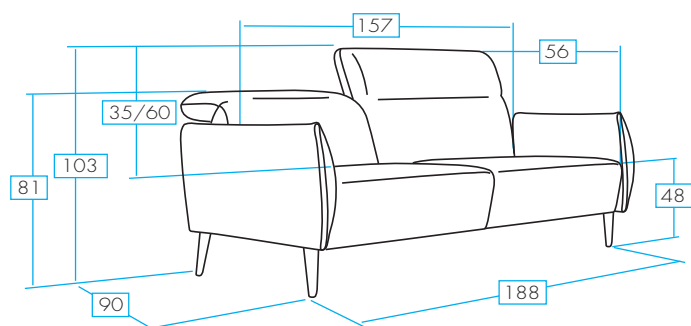

MAX.  
120  
Kg

COLOR: **MICROFIBRA NEGRO**



COLOR: **MICROFIBRA BEIGE**



ES

3 plazas: Fijo + 2 cabezales manuales.

EN

3 seats fixed + 2 manual headrests.

FR

Canapé 3 places fixe + 2 têtes manuels

PT

3 lugares fixo + 2 cabeçais manuais.





**CHITRA**  
EUROPEAN FURNITURE

## LUCCA

TELA / TISSU  
TECIDO / FABRIC

PANA

MAX.  
120  
Kg

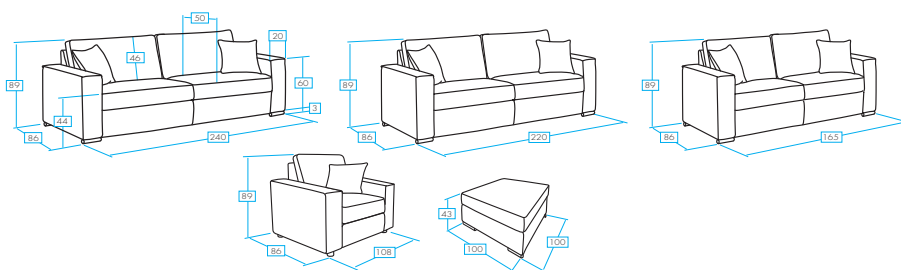

COLOR: TELA **PANA BLANCO**



ES

- Sofa 4 plazas fijo + Cojines
- Sofa 3 plazas fijo + Cojines
- Sofa 2 plazas fijo + Cojines
- Butaca fija + Cojín
- Pouff

PT

- 4 lugares fixo + almofadas
- 3 lugares fixo + almofadas
- 2 lugares fixo + almofadas
- Maple fixo + almofada
- Puff

FR

- Canapé 4 places fixe avec coussins
- Canapé 3 places fixe avec coussins
- Canapé 2 places fixe avec coussins
- Fauteuil fixe avec coussin
- Pouff

EN

- Fixed 4 seater sofa + Cushions
- Fixed 3 seater sofa + Cushions
- Fixed 2 seater sofa + Cushions
- Fixed armchair + Cushion
- Pouf

COLOR: TELA **PANA GRIS OSCURO**







**CHITRA**  
EUROPEAN FURNITURE

## MALLORCA

TELA / TISSU  
TECIDO / FABRIC

**TUI**



COLOR: TELA TUI CREMA

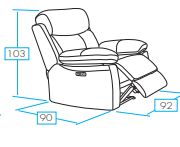
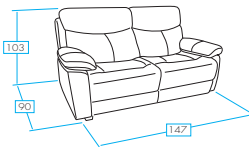
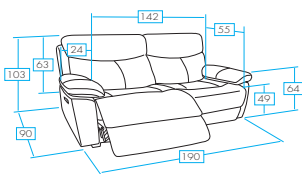

COLOR: TELA TUI GRIS PERLA

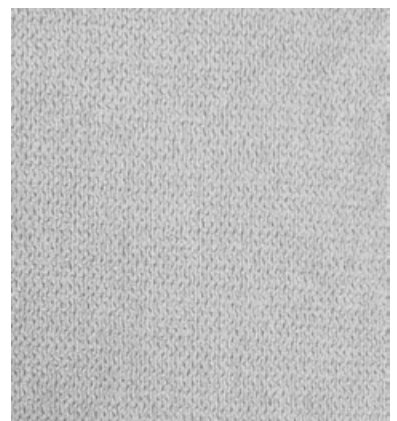

**ES**

- 3 plazas: 2 mecanismos relax eléctricos.
- 3 plazas: 2 mecanismos relax manuales.
- 2 plazas: fijo.
- Sillón: 1 mecanismo relax eléctrico.
- Sillón: 1 mecanismo relax manual.

**PT**

- 3 Lugares: 2 mecanismos relax elétricos.
- 3 Lugares: 2 mecanismos relax manuales.
- 2 Lugares: fixo.
- Maple: 1 mecanismo relax eléctrico.
- Maple: 1 mecanismo relax manual.

**FR**

- 3 places: 2 relax électriques.
- 3 places: 2 relax manuels.
- 2 places: Fixe.
- Fauteuil: 1 mécanisme relax électrique.
- Fauteuil: 1 mécanisme relax manuel.

**EN**

- 3 seats: 2 electric relax mechanisms.
- 3 seats: 2 manual relax mechanisms.
- 2 places: fixed.
- Armchair: 1 electric relax mechanism.
- Armchair: 1 manual relax mechanism.





RELAX ELÉCTRICOS

CHITRA  
EUROPEAN FURNITURE

## MONTANA

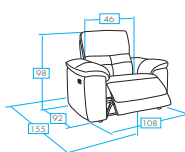
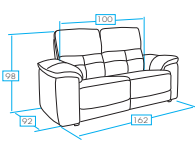
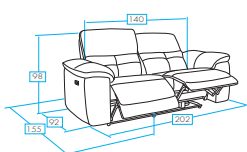
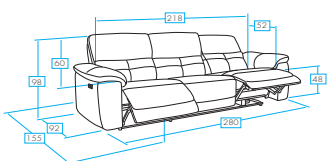

COLOR: **NEW NOBUCK BEIGE (Hilo blanco)**



COLOR: **NEW NOBUCK GRIS OSCURO (Hilo blanco)**

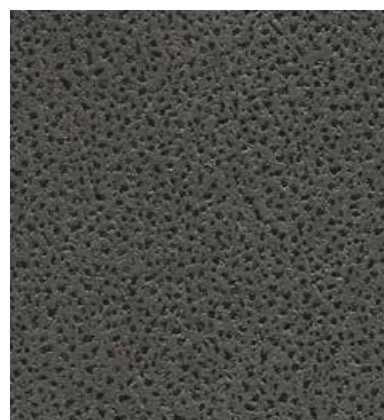

ES

- 4 plazas : 2 relax eléctricos.
- 3 plazas: 2 relax eléctricos.
- 2 plazas: fijo.
- Sillón: 1 relax eléctrico.

EN

- 4 seats: 2 electric relax.
- 3 seats: 2 electric relax.
- 2 seats: Fixed.
- Armchair: 1 electric relax.

FR

- 4 places: 2 relax électriques.
- 3 places: 2 relax électriques.
- 2 places: Fixe.
- Fauteuil: 1 relax électrique.

PT

- 4 Lugares: 2 relax eléctricos.
- 3 Lugares: 2 relax eléctricos.
- 2 Lugares: fixo.
- Maple: 1 relax eléctrico.





**CHITRA**  
EUROPEAN FURNITURE

## N I Z A

TELA / TISSU  
TECIDO / FABRIC

**SYR**

COLOR: TELA **SYR GRIS CLARO / GRIS**

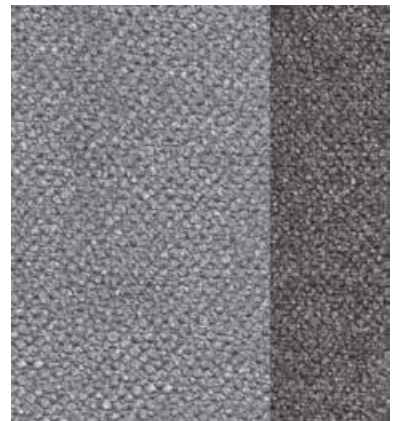
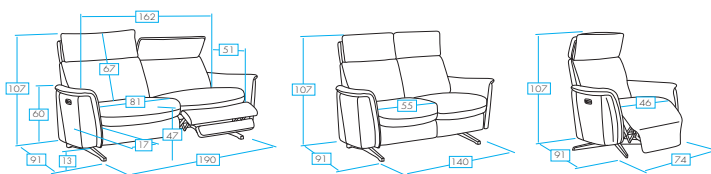

COLOR: TELA **SYR GRIS OSCURO / GRIS**

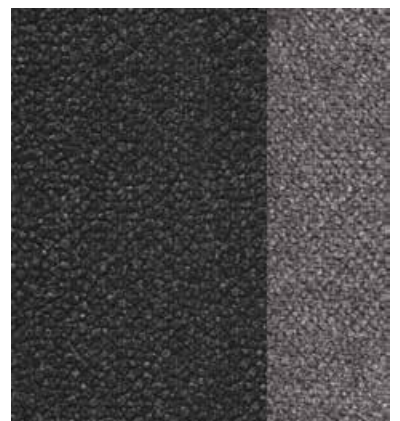

### ES

- 3 plazas: 2 relax eléctricos + 2 cabezales manuales + entrada USB y USB-C.
- 2 plazas: fijo.
- Sillón: 2 relax eléctricos + cabezal manual.

### PT

- 3 Lugares: 2 relax elétricos + 2 cabeçais manuais + entrada USB e USB-C.
- 2 Lugares: fixo.
- Maple: 2 relax elétricos + cabeçal manual.

### FR

- 3 places: 2 relax électriques + 2 têtières manuelles + USB et USB-C connexion.
- 2 places: Fixe.
- Fauteuil: 2 relax électriques + têtière manuelle.

### EN

- 3 seats: 2 electric relax + 2 manual headrests + USB and USB-C input.
- 2 seats: fixed.
- Armchair: 2 electric relax + manual headrest.





MECANISMO PARED "0"

**CHITRA**  
EUROPEAN FURNITURE

## O P O R T O

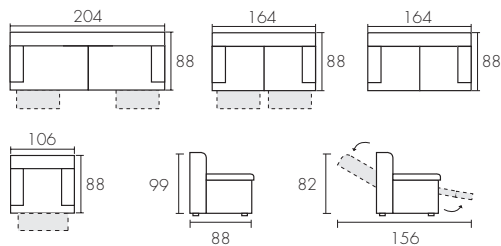

COLOR: **NEW NOBUCK GRIS** (hilo blanco)



COLOR: **NEW NOBUCK BEIGE** (hilo beige)



### ES

- 3 plazas: 2 mecanismos relax eléctricos.
- 3 plazas: 2 mecanismos relax manuales.
- 2 plazas: 2 mecanismos relax eléctricos.
- 2 plazas: 2 mecanismos relax manuales.
- 2 plazas: fijo.
- Sillón: 1 mecanismo relax eléctrico.
- Sillón: 1 mecanismo relax manual.

### EN

- 3 seats: 2 electric relaxing mechanisms.
- 3 seats: 2 manual relaxing mechanisms.
- 2 seats: 2 electric relaxing mechanisms.
- 2 seats: 2 manual relaxing mechanisms.
- 2 seats: Fixed.
- Armchair: 1 electric relaxing mechanism.
- Armchair: 1 manual relaxing mechanism.

### FR

- 3 places: 2 mécanismes relax électriques.
- 3 places: 2 mécanismes relax manuels.
- 2 places: 2 mécanismes relax électriques.
- 2 places: 2 mécanismes relax manuels.
- 2 places: Fixe.
- Fauteuil: 1 mécanisme relax électrique.
- Fauteuil: 1 mécanisme relax manual.

### PT

- 3 Lugares: 2 mecanismos relax eléctricos
- 3 Lugares: 2 mecanismos relax manuais
- 2 Lugares: 2 mecanismos relax eléctricos
- 2 Lugares: 2 mecanismos relax manuais
- 2 Lugares: fixo
- Maple: 1 mecanismo relax eléctrico
- Maple: 1 mecanismo relax manual





**CHITRA**  
EUROPEAN FURNITURE

## PARÍS

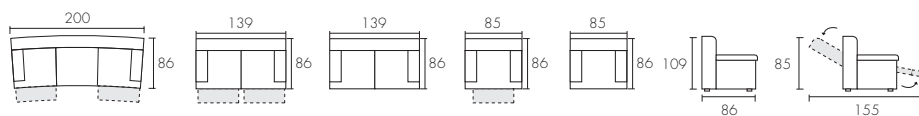

COLOR: **NEW NOBUCK BEIGE-GRIS OSCURO**



### ES

- 3 plazas: 2 mecanismos relax eléctricos + 2 cabezales eléctricos + Mesa respaldo central + entrada USB.
- 2 plazas: 2 mecanismos relax eléctricos + 2 cabezales eléctricos + entrada USB.
- 2 plazas: fijo.
- Sillón: 1 mecanismo relax eléctrico + Cabezal eléctrico + entrada USB.
- Sillón: fijo.

### EN

- 3 seats: 2 electric relaxing mechanisms + 2 electric headrests + Central backrest table + USB connection.
- 2 seats: 2 electric relaxing mechanisms + 2 electric headrests + USB connection.
- 2 seats: Fixed.
- Armchair: 1 electric relaxing mechanism + Electric headrest + USB connection.
- Armchair: Fixed.

### FR

- 3 places: 2 relax électriques + 2 têtes électriques + Table dossier centrale + USB connexion.
- 2 places: 2 relax électriques + 2 têtes électriques + USB connexion.
- 2 places: Fixe.
- Fauteuil: 1 mécanisme relax électrique + Tête électrique + USB connexion.
- Fauteuil: Fixe.

### PT

- 3 Lugares: 2 mecanismos relax eléctricos + 2 cabeçais eléctricos + Mesa central de encosto + entrada USB.
- 2 Lugares: 2 mecanismos relax eléctricos + 2 cabeçais eléctricos + entrada USB.
- 2 Lugares: fixo.
- Maple: 1 mecanismo relax eléctrico + Cabeça eléctrica + entrada USB.
- Maple: fixo.

COLOR: **NEW NOBUCK GRIS OSCURO-BEIGE**





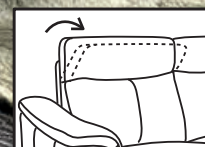

RELAX ELÉCTRICOS

CABEZALES MANUALES

**CHITRA**  
EUROPEAN FURNITURE

## S U I Z A



COLOR: **MICROFIBRA GRIS CLARO**

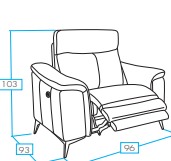
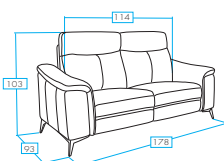
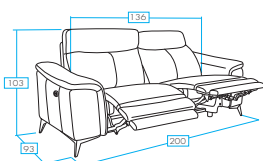
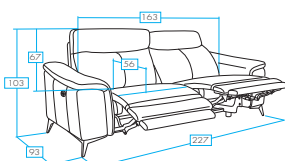

### ES

- 3 plazas: 2 mecanismos relax eléctricos + 2 cabezales manuales.
- 2,5 plazas: 2 mecanismos relax eléctricos + 2 cabezales manuales.
- 2 plazas: Fijo.
- Sillón: 1 mecanismo relax eléctrico + cabezal manual.

### EN

- 3 seats: 2 electric relaxing mechanisms + 2 manual headrests.
- 2,5 seats: 2 electric relaxing mechanisms + 2 manual headrests.
- 2 seats: Fixed.
- Armchair: 1 electric relaxing mechanism + manual headrest.

### FR

- 3 places: 2 relax électriques + 2 têtes manuelles.
- 2,5 places: 2 relax électriques + 2 têtes manuelles.
- 2 places: Fixe.
- Fauteuil: 1 relax électrique + tête manuelle.

### PT

- 3 Lugares: 2 relax eléctricos + 2 cabeçais manuais.
- 2,5 Lugares: 2 relax eléctricos + 2 cabeçais manuais.
- 2 Lugares: Fixo.
- Maple: 1 relax eléctrico + cabeçal manual.

COLOR: **MICROFIBRA GRIS OSCURO**







**CHITRA**  
EUROPEAN FURNITURE

## VERSALLES

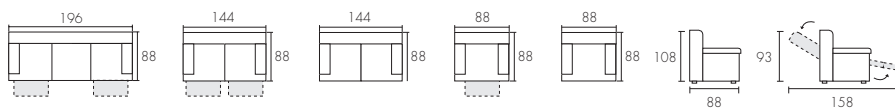

COLOR: **NEW NOBUCK GRIS OSCURO**  
(Hilo color gris claro)



COLOR: **NEW NOBUCK BEIGE** (Hilo color beige)



### ES

- 3 plazas: 2 mecanismos relax eléctricos + 2 cabezales eléctricos + Mesa respaldo central + entrada USB.
- 2 plazas: 2 mecanismos relax eléctricos + 2 cabezales eléctricos.
- 2 plazas: fijo.
- Sillón: 1 relax eléctrico y 1 cabezal eléctrico.
- Sillón: fijo

### FR

- 3 places: 2 relax électriques + 2 têtes électriques + Table dossier centrale + USB connexion.
- 2 places: 2 relax électriques + 2 têtes électriques.
- 2 places: Fixe.
- Fauteuil: 1 relax électrique avec tête électrique
- Fauteuil: Fixe

### EN

- 3 seats: 2 electric relaxing mechanisms + 2 electric headrests + Central backrest table + USB connection.
- 2 seats: 2 electric relaxing mechanisms + 2 electric headrests.
- 2 seats: Fixed.
- Armchair: 1 electric relaxing plus electric headrest.
- Armchair: Fixed

### PT

- 3 Lugares: 2 mecanismos relax eléctricos + 2 cabeçais eléctricos + Mesa central de encosto + entrada USB.
- 2 Lugares: 2 mecanismos relax eléctricos + 2 cabeçal eléctricos.
- 2 Lugares: fixo
- Maple: 1 mecanismo Relax eléctrico e cabeçal eléctrico
- Maple: fixo



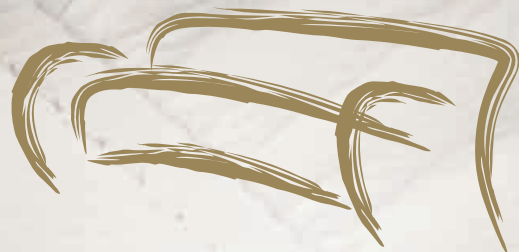

---

SOFÁS PIEL





MECANISMO PARED "0"

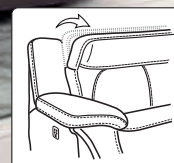

CABEZAL ELÉCTRICO

**CHITRA**  
EUROPEAN FURNITURE

## BILBAO PIEL

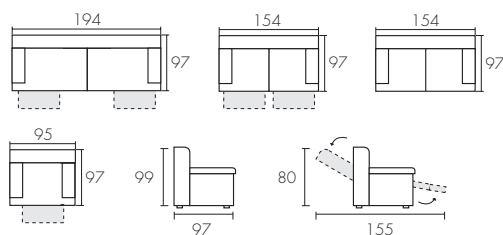

COLOR: **PIEL GRIS** (Hilo color naranja)



COLOR: **PIEL MARRÓN** (Hilo color naranja)



ES

- 3 plazas: 2 relax eléctricos y 2 cabezales eléctricos
- 2 plazas: 2 relax eléctricos y 2 cabezales eléctricos
- 2 plazas: fijo.
- Sillón: 1 relax eléctrico y 1 cabezal eléctrico.

EN

- 3 seats: 2 electric relaxing plus electric headrest.
- 2 seats: 2 electric relaxing plus electric headrest.
- 2 seats: Fixed.
- Armchair: 1 electric relaxing plus electric headrest.

FR

- 3 pl: 2 relax électriques et têtes électriques.
- 2 pl: 2 relax électriques avec têtes électriques.
- 2 pl: Fixe.
- Fauteuil: 1 relax électrique avec têtes électriques

PT

- 3 Lugares: 2 Relax elétricos y cabeçais
- 2 Lugares: 2 Relax elétricos y cabeçais
- 2 Lugares: fixo
- Maple: 1 mecanismo Relax eléctrico e cabeçal





RELAX Y CABEZALES ELÉCTRICOS



CABEZAL ELÉCTRICO

**CHITRA**  
EUROPEAN FURNITURE

## COLONIA PIEL

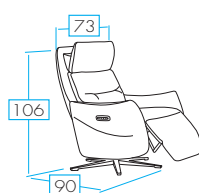
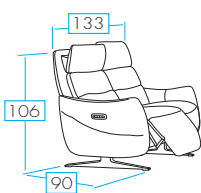
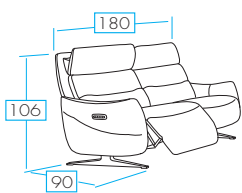

COLOR: **PIEL BEIGE**



COLOR: **PIEL NEGRO**



ES

- 3 plazas: 4 mecanismos relax eléctricos + 2 cabezales eléctricos + entrada USB.
- 2 plazas: 4 mecanismos relax eléctricos + 2 cabezales eléctricos + entrada USB.
- 2 plazas: fijo.
- Sillón: 2 mecanismos relax eléctrico + Cabezal eléctrico + entrada USB.

EN

- 3 seats: 4 electric relaxing mechanisms + 2 electric headrests + USB connection.
- 2 seats: 4 electric relaxing mechanisms + 2 electric headrests + USB connection.
- 2 seats: Fixed.
- Armchair: 2 electric relaxing mechanisms + electric headrest + USB connection.

FR

- 3 places: 4 mécanismes relax électriques + 2 têtes électriques + USB connexion.
- 2 places: 4 mécanismes relax électriques + 2 têtes électriques + USB connexion.
- 2 places: Fixe.
- Fauteuil: 2 mécanismes relax électriques + tête électrique + USB connexion.

PT

- 3 Lugares: 4 mecanismos relax eléctricos + 2 cabeçal eléctricos + entrada USB.
- 2 Lugares: 4 mecanismos relax eléctricos + 2 cabeçal eléctricos + entrada USB.
- 2 Lugares: fixo.
- Maple: 2 mecanismos relax eléctricos + cabeçal eléctrico + entrada USB.





**CHITRA**  
EUROPEAN FURNITURE

## JAMAICA

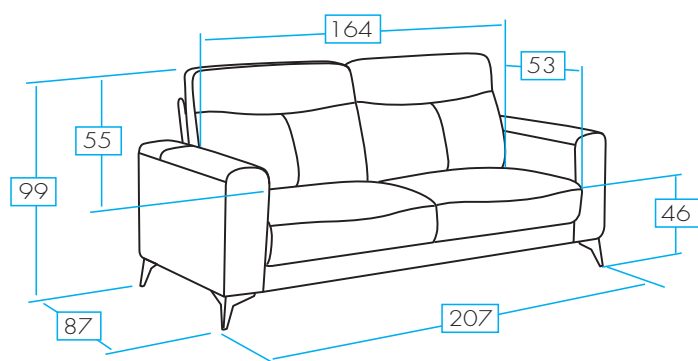

MAX.  
120  
Kg

COLOR: **PIEL NEGRO**

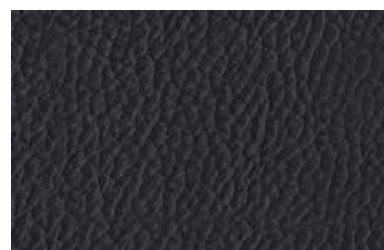

COLOR: **PIEL ROJO**



COLOR: **PIEL MARRÓN**



ES

Sofá 3 plazas fijo

EN

Sofa 3 seats fixed.

FR

Sofá 3 places fixe

PT

Sofá 3 lugares fixo





**CHITRA**  
EUROPEAN FURNITURE

## PRESTON

TODO PIEL / TOUT CUIR  
TUDO PELE / ALL LEATHER



COLOR: TODO PIEL **GRIS**

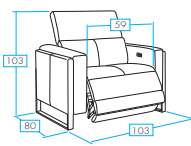
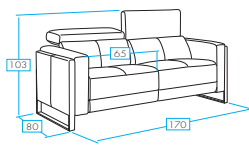
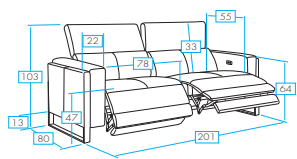

COLOR: TODO PIEL **COGNAC**



### ES

- 3 plazas: 2 relax eléctricos + 2 cabezales manuales + entrada USB.
- 2 plazas: Fijo + 2 cabezales manuales.
- Sillon: 1 relax eléctrico + 1 cabezal manual
- + entrada USB.

### PT

- 3 Lugares: 2 relax eléctricos + 2 cabeçais manuais + porta USB.
- 2 Lugares: fixo + 2 cabeçais manuais.
- Maple: 1 relax eléctrico + 1 cabeçal manual
- + porta USB.

### FR

- 3 places: 2 relax électriques + 2 têtes manuelles + USB connexion.
- 2 places: Fixe + 2 têtes manuelles.
- Fauteuil: 1 relax électrique + 1 tête manuelle
- + USB.

### EN

- 3 seats: 2 electric relax + 2 manual headrests + USB input.
- 2 places: Fixed + 2 manual headrests.
- Armchair: 1 electric relax + 1 manual headrest
- + USB input.





**CHITRA**  
EUROPEAN FURNITURE

## NICOLA

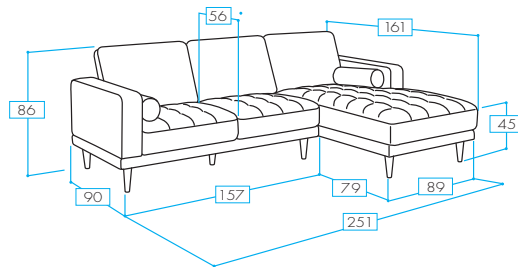
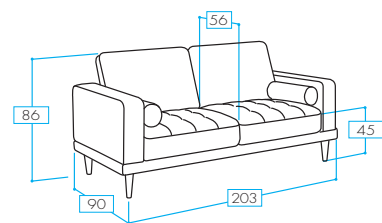

MAX.  
120  
Kg

COLOR: **TELA GRIS OSCURO**



COLOR: **TELA GRIS CLARO**



ES

- Sofá 3 plazas fijo + cojines.
- Chaiselongue fija + cojines

EN

- 3 seats fixed + cushions
- Chaise longue fixed + cushions

FR

- Canapé 3 places fixe avec coussins.
- Chaiselongue fixe avec coussins.

PT

- Sofá 3 lugares fixo + almofadas.
- Chaise loingue fixo + almofadas.



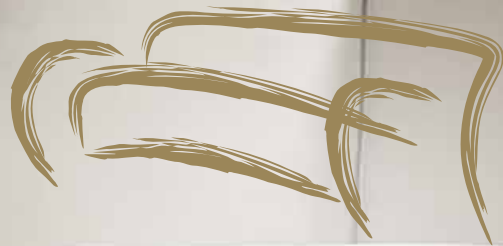

RINCONERAS





**CHITRA**  
EUROPEAN FURNITURE

## LEMANS

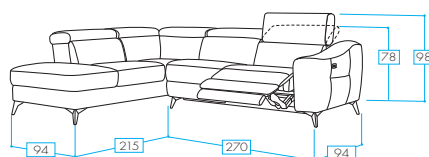
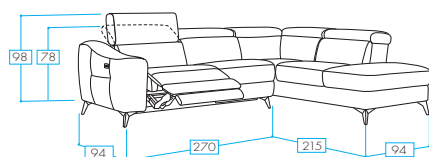

COLOR: **MICROFIBRA GRIS OSCURO**  
(Bordón gris claro)



COLOR: **MICROFIBRA GRIS CLARO**  
(Bordón gris oscuro)



ES

- Rinconera: 1 Mecanismo relax eléctrico
- + 5 Cabezales manuales
- + cofre
- + Entrada USB
- Bolsillo lateral

EN

- Angle: 1 Electric relaxing mechanism
- + 5 Manual headrests
- + Storage box
- + USB connection
- Side pocket

FR

- Canapé angle: 1 Relax électrique
- + 5 Têteières manuelles sur cremaillère
- + Coffre
- + USB connexion
- Poche latérale

PT

- Rinconera: 1 Mecanismo relax eléctrico
- + 5 Cabezales manuais
- + Cofre
- + USB
- Bolso lateral



MECANISMO PARED "0"



5 CABEZALES MANUALES



APOYABRAZOS REGULABLE

CHITRA  
EUROPEAN FURNITURE

## SANTANDER

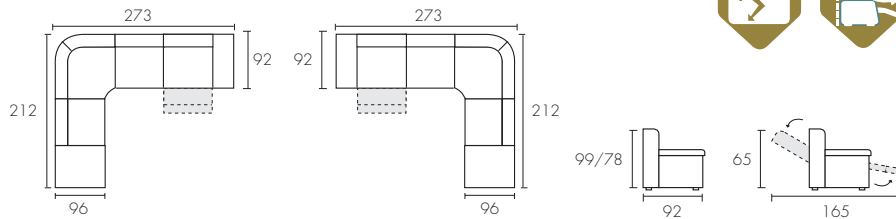

COLOR: **MICROFIBRA GRIS OSCURO**  
(Hilo color dorado)



COLOR: **MICROFIBRA GRIS CLARO**  
(Hilo color gris claro)

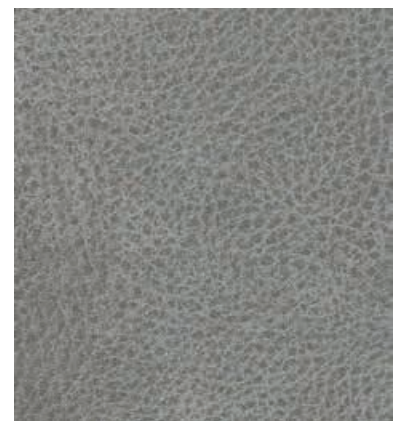

ES

- Rinconera: 1 Mecanismo relax eléctrico
- + 5 Cabezales manuales
- + Arcón
- + Apoyabrazo regulable.

EN

- Angle: 1 Electric relaxing mechanism
- + 5 Manual headrests
- + Storage box
- + Adjustable armrest

FR

- Canapé angle: 1 Relax électrique
- + 5 Têteières manuelles
- + Coffre
- + 1 Appui bras manuel.

PT

- Rinconera: 1 Mecanismo relax eléctrico
- + 5 Cabezales manuais
- + Cofre
- + Apoio de braço ajustável





**CHITRA**  
EUROPEAN FURNITURE

## SEGOVIA

TELA / TISSU  
TECIDO / FABRIC

**CIEN**

MAX.  
**120  
Kg**

COLOR: TELA **CIEN GRIS OSCURO**

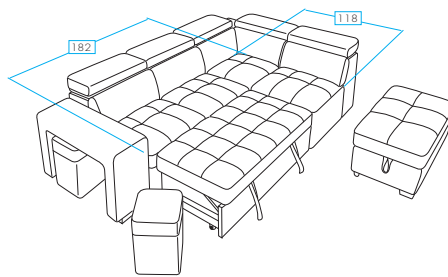
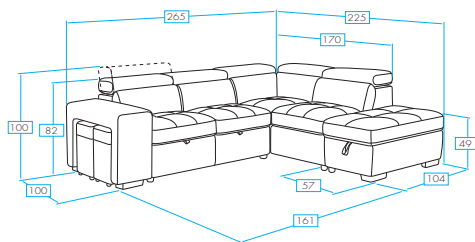

COLOR: TELA **CIEN BEIGE**



**ES**

- Rinconera cama  
+ 5 Cabezales manuales  
+ Cofre  
+ 2\* Pouffs.

**EN**

- Corner bed  
+ 5 manual heads  
+ Chest  
+ 2\* Pouffes.

**FR**

- Canapé angle - lit  
+ 5 Têtières manuelles  
+ Coffre  
+ 2\* Pouffs

**PT**

- Sofá de canto-cama  
+ 5 Cabeçais manuais  
+ Baú  
+ 2\* Pouffs.

**CHITRA**  
EUROPEAN FURNITURE

CHITRA EUROPEAN FURNITURE: Tel. 0034 972 306 160 - e-mail: [info@chitra-european.es](mailto:info@chitra-european.es)